









NORDIC N400 Marine HID

The marine version of the N400 HID comes with all the same features as the standard N400 HID range while also utilising stainless steel components to conform to marine standards.

IP67 rated guarantees continuous lighting even in the roughest conditions. Available in both flood and wide flood light patterns assures optimum illumination to suit your vessel.

-  Heavy duty 5000 hr* 35W DIS Xenon discharge bulb
-  Over voltage, over temperature & spike protected
-  Heavy duty anti-vibration mounting system with stainless steel bracketing
-  Low current draw
-  Deutsch DT series 2 pin connector on fly lead
-  Polarity protected ballast encapsulated in body

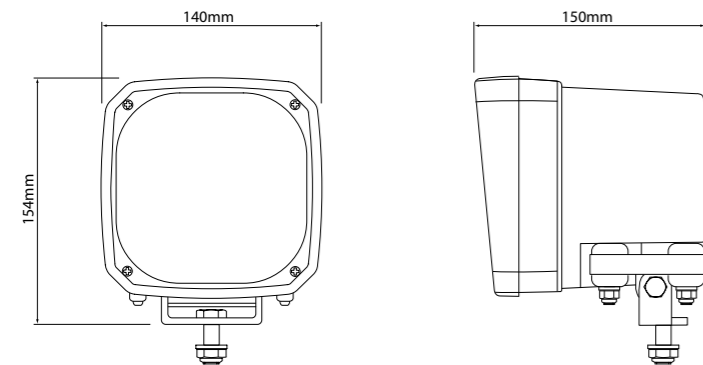

Nordic N400M HID Specifications

Voltage :	12V	24V
Start Up :	6.0 Amps	2.9 Amps
Input Current :	3.6 Amps	1.7 Amps
Connector :	Deutsch DT Series 2 Pin	
Mount :	Single Bolt M10	
Shock :	50 G	
Vibration :	12 G _{rms} 24 - 2000 Hz	
Body :	Glass Fibre Reinforced Polymer	
Weight :	1.4 kg	
IP Rating :	IP67	
Salt Mist :	IEC 60068-2-11	
Operating Temperature :	-40° to + 85°	

Refer to page 10 for full spec listing.

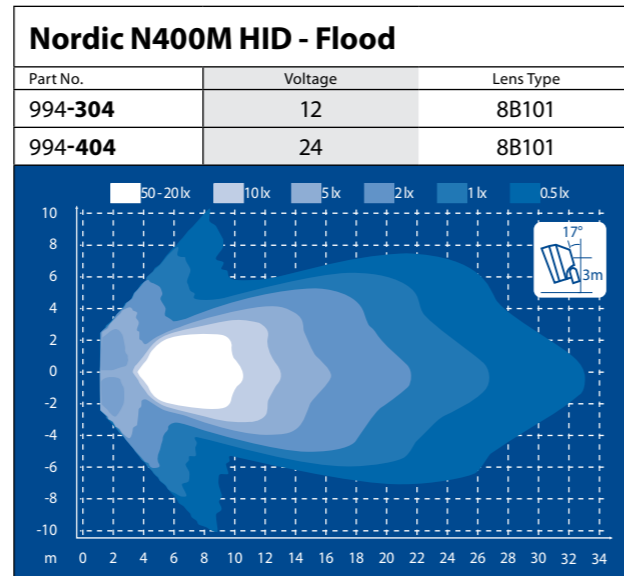
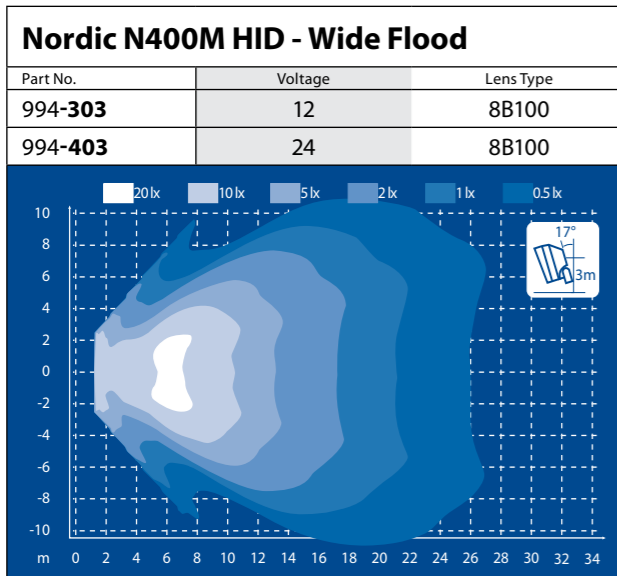

NORDIC Marine Halogen

Vision Alert offers both the N25 and N100 halogen worklamps in marine standard ensuring there's a halogen worklamp to suit your water going needs.

Possessing all the same features as the standard equivalents, the N25 and N100 marine halogen worklamps are fitted with a stainless steel mounting brackets and hardware eliminating the possibility of corrosion.



-  Heavy duty bulb holder & heatsink*. *N100M only
-  Heavy duty anti-vibration mounting system
-  Deutsch DT series 2 pin connector moulded into body
-  Rotate lens for pendant, lefthand or righthand side mount
-  Two flood light patterns to choose from
-  'O' ring seal to stop dust & water ingress



Marine Halogen Specifications

Voltage :	12V	24V
Input Current :	4.6 Amps	2.7 Amps
Connector :	Deutsch DT Series 2 Pin	
Mount :	Single Bolt M8	
Vibration :	8.6 G _{rms} 24 - 2000 Hz	
Lens :	Hardened Glass	
Body :	Polymer	
Weight :	0.5 kg	
IP Rating :	IP67	
Operating Temperature :	-40° to + 85°	
Colour Temperature.:	3000 K	
Bulb :	12V 55W H3	24V 70W H3

